

Model	VC3016GHTQY.CAEPLGT		
Language	English+Chinese		
Page	32	Color(cover/body)	4/2
Material	Weight 100g	Size(W*H)	150 x 220(mm)
Date	2010.08.24	Designer	GuoWei
Part No.	MFL66099704	Description	Owner's manual

Chage Record

No.	Change content	ECO No.	Date	Designer	Confirm
①					
②					
③					
④					
⑤					
⑥					
⑦					
⑧					
⑨					

使用说明书

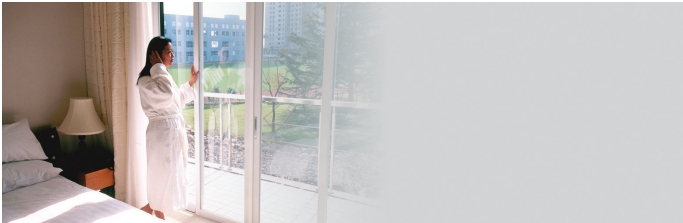

吸尘器

强劲吸力

VC3016GHTQY

中文 ——> 1-16页

English ——> Page 17-31

售后服务电话



使用前请仔细阅读说明书，阅读完后请妥善保管以备需要时查阅。

目 录

产品规格	2
使用前注意事项	3-4
吸尘器的组装及吸力调节	5
部分名称与连接方法	
附件	
吸力调节	
尖吸嘴 鸭嘴 毛刷的使用及角落刷头的使用与清洁方法	6
震动刷头的使用方法与清洗方法	7
使用方法	
清洗方法	
地板刷头的使用方法	8
集尘桶的拆卸 / 清理方法	9
灰尘分离器的清理方法	
集尘桶、灰尘分离器的清理 / 安装方法	10
清洗方法	
安装方法	
电机保护过滤器的拆卸 / 洗涤 / 安装方法	11
拆卸方法	
清洗方法	
排气过滤器的拆卸/清理/安装方法	12
拆卸方法	
清理方法	
安装方法	
申报故障维修前的确认事项	13
拆卸方法	
清洗方法	
故障通告前需确认事项	14-15
故障通告前请先确认	
装箱单	16

产品规格

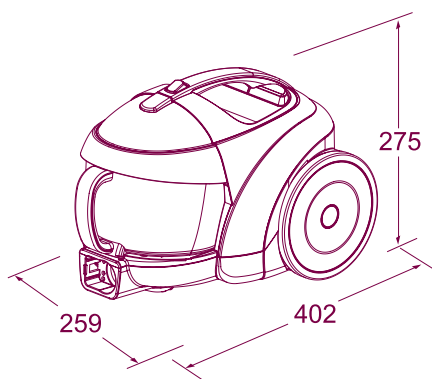



型号: VC3016GHTQY
额定电压: 220V~ 50Hz
额定功率: 1400W
最大功率: 1600W
吸率: 400W
净重: 5.0Kg
集尘容量: 1.2L
外形尺寸: 402mmx259mmx275mm
本产品执行标准: GB4706.1-2005
GB4706.7-2004
GB17625.1-2003
GB4343.1-2009

※ 为了提高产品质量而进行的外观及设计规格上的变更将不再另行通知。

使用前注意事项

使用前注意事项

忽视说明而导致的错误操作将会对您造成不同程度的损害，请认真阅读以下提示说明。

-  **危险** 此标识表明违反标记事项时，会立刻发生严重伤害或死亡现象。
-  **警告** 此标识表明违反标记事项时，有可能发生严重伤害或死亡现象。
-  **注意** 此标识表明违反此标记事项时，有可能发生财产损失或轻微伤害。

危险

请不要在易燃液体附近使用吸尘器，以免发生火灾。



插拔电源插头时，请先关闭电源开关，以免发生火灾或触电的危险。请不要用湿手触摸电源插头，以防触电。（不要在220V以外的电源上使用产品）

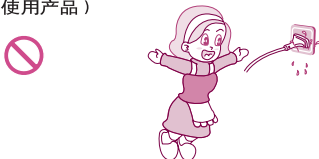

警告

请不要让大头钉等金属物存留在软管、机体延长管内，否则会造成短路故障。请不要吸入头发团、大纸团等物品，否则容易堵塞软管，如有堵塞现象，请及时清理。

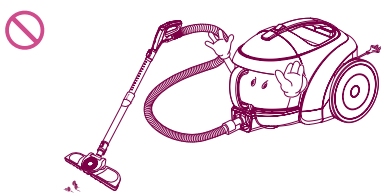

为避免发生火灾或触电的危险，在清扫时，注意不要让机体吸入液体、刀片、火种以及水泥、石膏粉等小微粒。

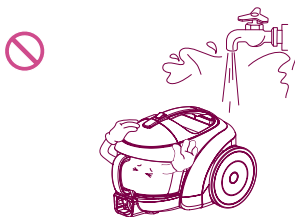

15A以上的电流请单独使用插线板，在一个插线板上同时使用多种电器可能会引发火灾。建议不要使用电源线延长线，以免引起不必要的危险。本吸尘器最大电流为6A。



长时间不使用电器时，请记住拔掉电源插头；正处于通电时，请您不要离开。

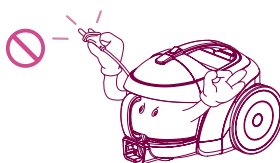

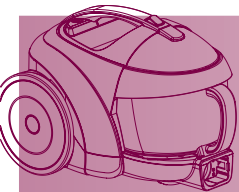

使用前注意事项

警告

请不要让电源线与吸尘器接近电暖器等热源，以免机体变形或发生火灾。请您不要使用破损的电源和插头，如有破损，必须由指定维修站更换。

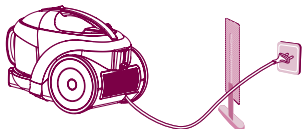

请不要让儿童把吸尘器及组件，如延长管等当做玩具，防止意外。



请不要在吸入口和排气口堵塞时，继续长时间运作，否则可能造成机体变形或损坏。

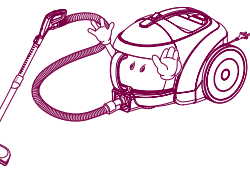

使用过程中，延长管和机体有产生静电的可能，请您使用时注意。

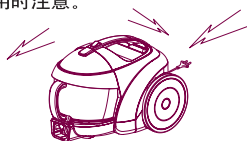

注意

非专业维修人员请勿开机修理。

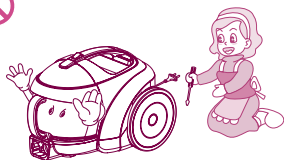

注意不要使电源线夹在门缝里或用电源线提拉吸尘器，防止电源线受损。

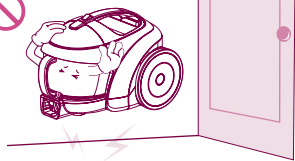

收卷电线时，请拿住电源插头后再按动卷线器按钮。

请不要将电源线拉至红色警告线以外，否则可能损坏电源线或不能回卷。收线时请注意插头，以免损坏周围物品。



请不要弯曲、践踏、拉拽软管，如软管受损，请不要继续使用。

请不要用重物或尖刃物压线。

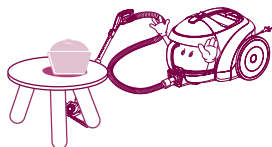

集尘筒集满时，请您正确开启集尘筒清理。请您注意不要在没安装集尘筒或过滤网时使用吸尘器。

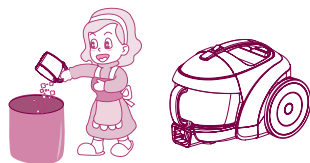

请您注意保护自身安全，使身体各部位远离吸尘器吸口或活动部位。

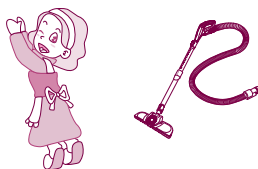

吸尘器的组装及吸力调节

部分名称与连接方法

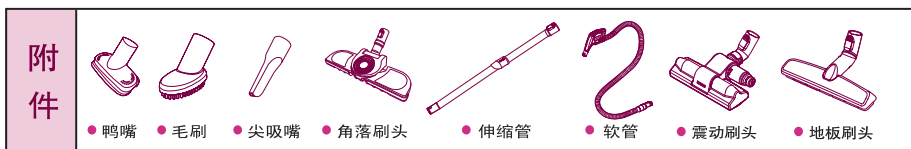
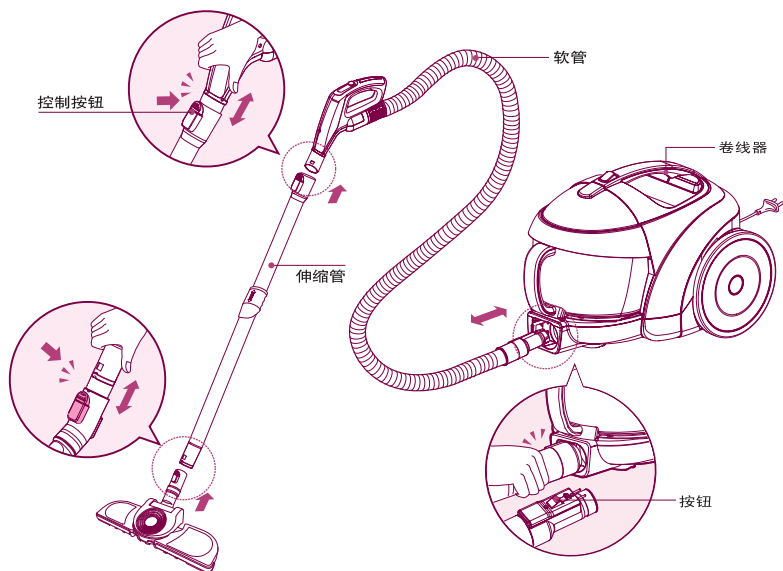

吸力调节

请按图示使用

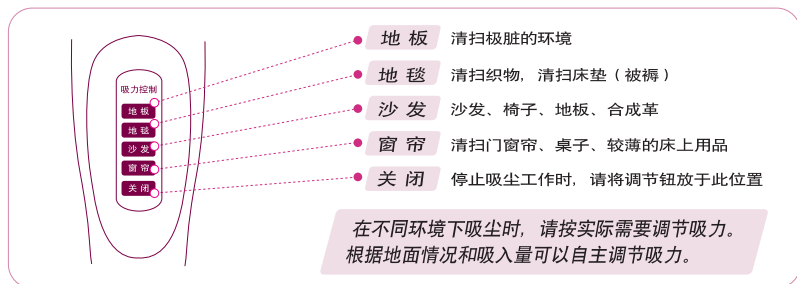

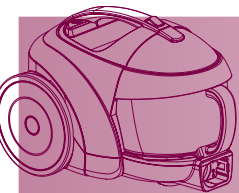

尖吸嘴 鸭嘴 毛刷的使用及角落刷头的使用与清洁方法

尖吸嘴的使用

请按图示使用

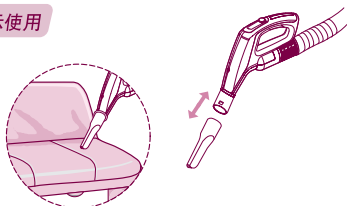

使用方法

尖嘴吸可以用来清理房间角落等不易清理到的地方。

鸭嘴与毛刷

▶ 打开附件袋，取出附件。

使用方法

请按图示使用

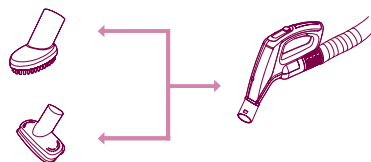

用来清洁一般不容易接触的地方，如窗框，墙缝，画框，家具边缘，书或其它不平物体。

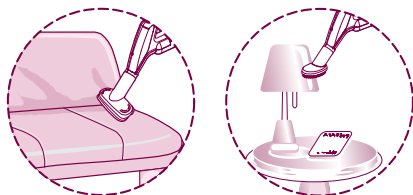

▶ 鸭嘴是用来对饰物、床垫等物品进行吸除的。

▶ 毛刷用于吸扫画框、家具边沿、书籍和其它不规则的表面。

角落刷头的使用

组合

▶ 角落刷头可以清洁普通地面，也可以折叠成直角来清洁墙角。

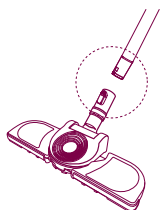

使用

▶ 不用再为清扫角落和窄小空间发愁，**角落刷头**会给您带来更多便利。

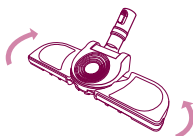

清洁

① 用尖吸嘴清洁

② 用棉质抹布擦拭

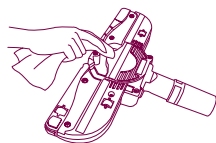
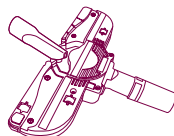

震动刷头使用方法与清洗方法

震动刷头使用方法

请按图示使用

组合



使用



手柄调节至“地毯”档。根据织物种类不同，吸力大小要有所改变，应视情况不同来调节控制键。

最佳效果清扫方法

• 床、床褥、厚棉被

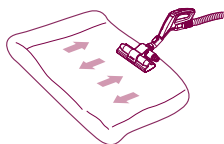

• 薄被、毛毯

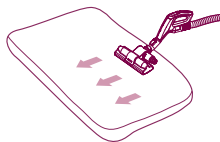









清扫薄被时，下面垫一个厚被，效果更理想！

- 若震动拍不运作，可轻轻向地面敲打刷头后再使用。
- 如还不震动，检查一下振动拍是否被棉絮卡住或需要调大吸力。
- 集尘筒集满灰尘或吸力减小，震动幅度相应减小时，应注意及时清理滤芯。

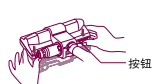
震动刷头清洗方法

▶ 用水清洗吸入口，有可能导致振动器故障。

-  1 清洁过程中集尘瓶内灰尘较多时，按2~3次按钮。
(可彻底去除灰尘)
-  2 清洁结束后集尘瓶内灰尘较多时，握住集尘瓶向逆时针方向转动拆卸。
-  3 倒掉集尘瓶内的灰尘。
-  4 握住集尘瓶，对准凸起部，按顺时针方向转动安装。
凸起部
-  5 按下吸入口背面的按钮，卸下底板。
按钮
-  6 用抹布擦拭吸入口的污染面。
-  7 用水冲洗卸下的底板后，置于阴凉处晾干。
-  8 整齐地放置底板的振动板。
振动板
-  9 将突起部插入凹槽部内。
突起部
凹槽部
-  10 向下按，确保底板安装正确。

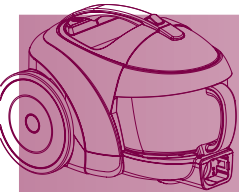

地板刷头的使用方法

地板刷头的使用

组合

- ▶ 地板刷头可以清洁普通地面。

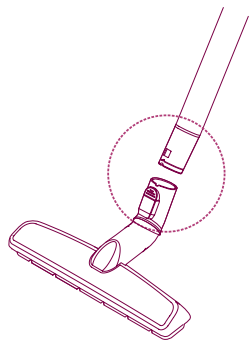

使用

- ▶ 不用再为清扫地板发愁，此刷头会给您带来更多便利。

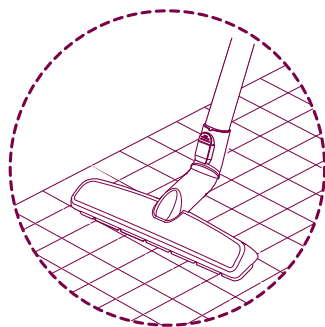

集尘桶的拆卸/清理方法

- 注意：**
- 集尘量达到集尘桶上标记的MAX线时，清理集尘桶。
 - 集尘量超过MAX时，吸入力可能降低。
 - 集尘桶至少三个月清洗一次，或根据使用频率酌情清理。

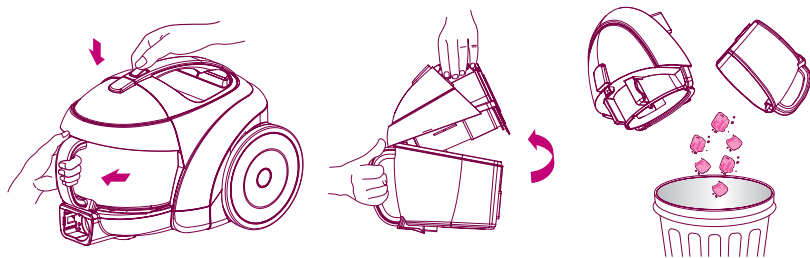

1 一手按住主机盖按钮，另一手握住集尘桶手柄，取下集尘桶。

2 手握集尘桶盖子上的小把手，打开集尘桶。

3 倒掉灰尘。

灰尘分离器的清理方法

- 注意：**
- 清洁集尘桶时，检查灰尘分离器内部。
 - 灰尘分离器内部有很多废纸、塑料等异物时，可能降低吸入力，请及时清理灰尘分离器。
 - 灰尘分离器至少三个月清洗一次，或根据使用频率酌情清理。

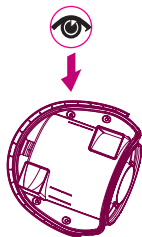

1 检查灰尘分离器内部是否有灰尘。

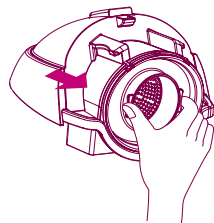

2 握住灰尘分离器盖的手柄拆卸盖子。

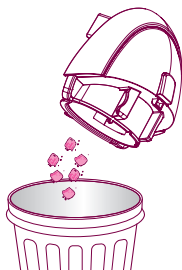

3 倒掉灰尘。

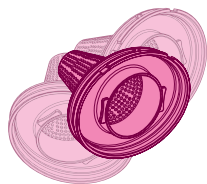

4 抖掉堵住灰尘分离器盖小孔的灰尘。

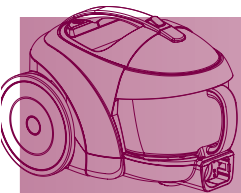

集尘桶、灰尘分离器的清洗/安装方法

清洗方法

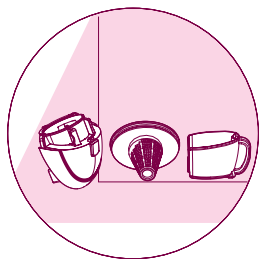
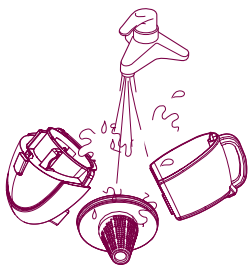

- 冲洗干净集尘桶、灰尘分离器、灰尘分离器盖。
- 在阴凉、通风处干燥一天左右，待完全干燥再使用。

安装方法

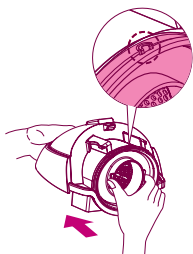

- 1 对准灰尘分离器盖的突起部和灰尘分离器槽后安装盖子。

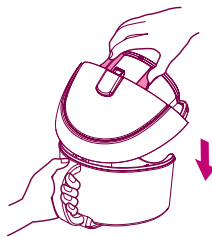

- 2 安装灰尘分离器和集尘桶。

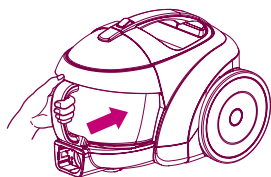

- 3 将集尘桶安装在吸尘器上。

注意：● 当手握把手将机体提起移动时，请不要用手指按动物体上方的按钮，那样容易导致集尘桶从机体上脱落。

● 在没有安装灰尘分离器盖的情况下使用吸尘器时，有可能出现噪音变大、吸入力急剧降低的现象，所以请务必再次确认是否安装好。

电机保护过滤器的拆卸/洗涤/安装方法

拆卸方法

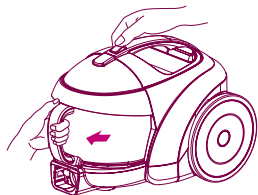

1 一手按住主机盖按钮，另一手取下集尘桶。

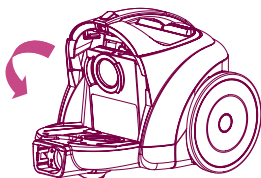

2 拆卸集尘桶后，从主机取出电机保护过滤器。

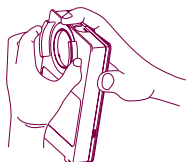

3 打开电机保护过滤器。

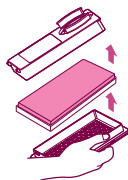

4 取出过滤海绵。

清洗方法

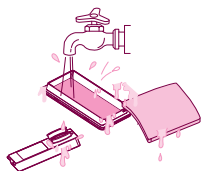

1 冲洗干净



2 彻底去除水分

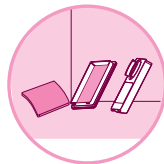

3 在阴凉、通风处干燥一天左右，待完全干燥后再使用。

注意：• 安装方法与拆卸方法相反。

• 在没有安装电机保护过滤器的情况下使用吸尘器时，可能出现噪音变大、灰尘进入电机，导致产品寿命缩短等现象，所以请再次确认安装情况。

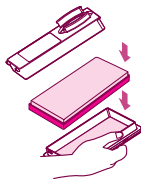

1 将电机保护过滤器装入过滤器外壳内。



2 盖上过滤器盖。

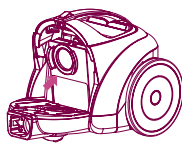

3 将组装好的过滤器放入安装部位。

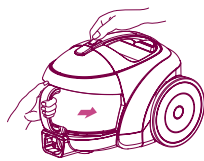

4 装入集尘桶。

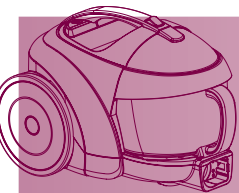

排气过滤器的拆卸/清理/安装方法

拆卸方法

- ▶ 排气过滤器至少半年清理一次或根据使用频率酌情清理。

排气过滤器盖按钮

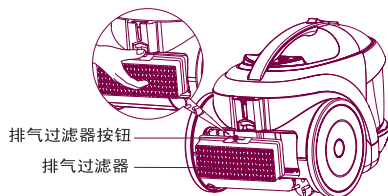
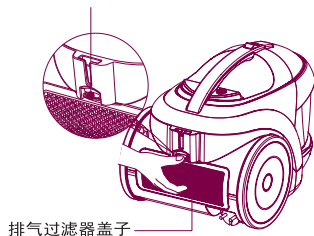

清理方法



- 1 抖动排气过滤器进行清理。

安装方法

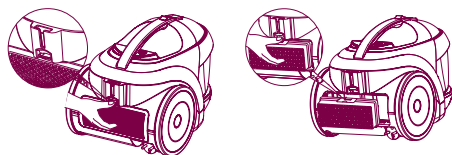

- 2 放入排气过滤器，按钮处有“咯哒”声时，表示排气过滤器盖安装准确。

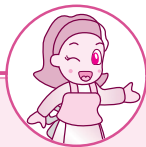

使用吸尘器后的保管方法

卷线器按钮

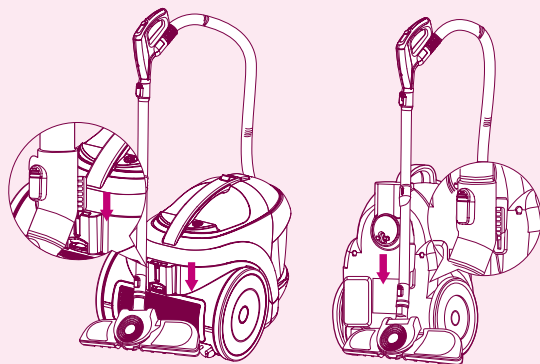
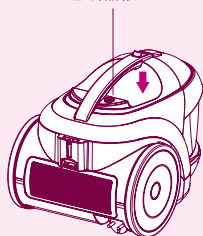

- 按下卷线器按钮时吸尘器电线自动被卷入。
- 吸入口的突起部插入主机背面或底面的凹槽后进行保管。

申报故障维修前的确认事项

- ▶ 我们应该避免产品并没有出现故障，却因申请维修服务而带来的不必要的麻烦。产品出现异常时，在申请服务中心或代理店的服务之前请确认以下事项。或许按照使用说明书的简单操作就可以解决了。

吸入力差？

第一阶段 确认吸入力调节键是否设置在最强位置

第二阶段 清洗电机保护过滤器。

拆卸方法

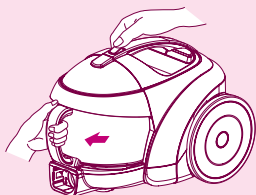

1 一手按住主机盖按钮，另一手取下集尘桶。

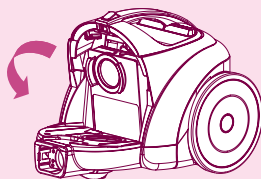

2 拆卸集尘桶后，从主机取出电机保护过滤器。

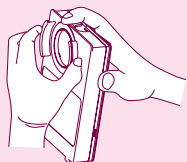

3 打开电机保护过滤器。

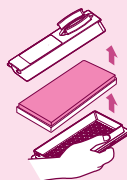

4 取出过滤海绵。

清洗方法 (用凉水清洗)

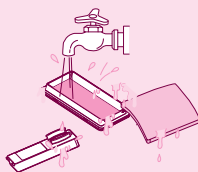

1 冲洗干净



2 彻底去除水分



3 在阴凉、通风处干燥一天左右，待完全干燥后再使用。

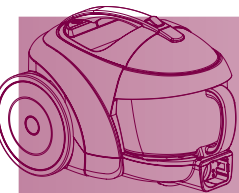

故障通告前需确认事项

故障通告前请先确认

- ▶ 如果您怀疑产品发生故障，请先确认故障发生原因，再与售后服务中心或代理商联系，以确保检修的效率。

现象：

噪音加大
软管收缩



吸力忽然
下降

吸尘器求助：

请检查集尘筒
和吸入口



处理要领

- 1 查看集尘筒灰尘是否集满（到达MAX处），如果是，请及时清理集尘筒。



已经满了吗？请及
时清理集尘筒哦！

- 2 请确认集尘筒滤芯是否堵塞
过滤器堵塞时会发出异常声，请及时清洗。



滤芯有问题吗？那么
检查一下吸入口。

- 3 检查吸入口时，需将吸力调节到最大。

第一步

将伸缩管与刷头分离后，检查有无阻塞，如发现问题请立即清理。

如果还有问题，
请进行第二步。

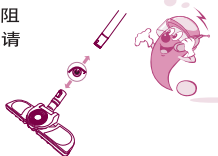

第二步

分离手柄与伸缩管，检查有无阻塞，如有阻塞，请将伸缩管收短，清除异物。

如果还有问题，
请进行第三步。



第三步

检查软管是否阻塞，将吸力调至最强，用手堵放管口，反复几次。

如果还有问题，
请清理一下滤芯。

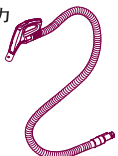

故障通告前请先确认

► 如果您怀疑产品发生故障，请先确认故障发生原因，再与售后服务中心或代理商联系，以确保检修的效率。

故障

吸尘器为何不能工作？

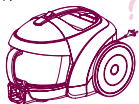

- 电源插头是否插上？
- 电源插座有电吗？
- 软管是否插上？
- 电机热保护处于开启期间。

措施

- 请将电源插牢（本产品适用于220V电压）。
- 确认插座是否有电。
- 将软管插牢。
- 2小时后重新启动。

机体内有噪音。



- 吸尘器吸力过大或电机高速运转时所发出的声音，不属于异常情况，请正常使用。
- 如果不是正常的电机响声，而是异常的噪音，请打电话与维修中心联系。
- 集尘筒已满。
- 集尘筒滤芯堵塞。
- 吸入口阻塞。
- 伸缩管阻塞。
- 软管阻塞。
- 清理集尘筒。
- 用软毛刷轻轻刷滤芯，用水冲洗后放置于阴凉处风干一天。
- 将吸入的异物取出后再使用。
- 将伸缩管内异物取出后再使用。
- 将软管内异物取出后再使用。

机体出现异味。



- 电机运作时，用于固定电机的橡胶圈会受热而产生少量气味，不会影响运作或使机器发生损坏。
- 机器不小心吸入一些水或集尘筒长期不清理时，会有一些异味排出，此时应及时清理集尘筒。

电源线不能全部卷入机体，电源线不能全部拉出。



- 将电源线拉出一部分后重新卷入。
- 请用力将电源线拉出，不会损坏电源线。
- 由于线在内部互相缠绕或夏季周围温度过高所致。
- 由于线在内部折曲或未缠在卷线器上，启动卷线器后，能正常运作。

机体或排出的气体过热。



- 吸力是否正常？

- 从机体内排出的热气，是由电机导热产生的热量所致，属正常温度，请继续使用。

软管内壁过脏。

- 请勿将水吸入，水与灰尘混合吸入后，有可能弄脏管壁。

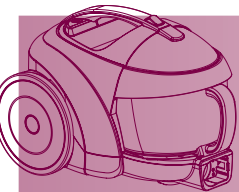

装箱单

装箱单

吸尘器	一台
说明书	一本
鸭嘴	一个
毛刷	一个
尖吸嘴	一个
软管	一根
伸缩管	一根
角落刷头	一个
震动刷头	一个
地板刷头	一个
保修卡	一份

Table of contents

<i>Product specifications</i>	17
<i>Attention before using the appliance</i>	18 ~ 19
Assembling and adjusting the Cleaner	20
<i>Parts description and assembly</i>	
<i>Accessories</i>	
<i>Adjusting the cleaner</i>	
<i>Using crevice tool, upholstery nozzle, dusting brush, corner nozzle and cleaning the corner nozzle</i>	21
<i>Using and cleaning the Sani Punch</i>	22
<i>Using the Sani Punch</i>	
<i>Cleaning the Sani Punch</i>	
<i>Using hard floor nozzle</i>	23
<i>How to separate or empty the dust box</i>	24
<i>How to empty the dust separator</i>	
<i>How to clean and assemble the dust box and separator</i>	
	25
<i>Cleaning</i>	
<i>Assembling</i>	
<i>How to separate, clean and assemble the protection filter of the motor</i>	26
<i>Disassembling</i>	
<i>Cleansing</i>	
<i>How to separate, clean and assemble exhaust filter</i>	27
<i>Disassembling</i>	
<i>Cleansing</i>	
<i>Assembling</i>	
<i>Check before reporting the trouble</i>	28
If you have a problem	29 ~ 30
<i>Packing List</i>	31

Product specifications

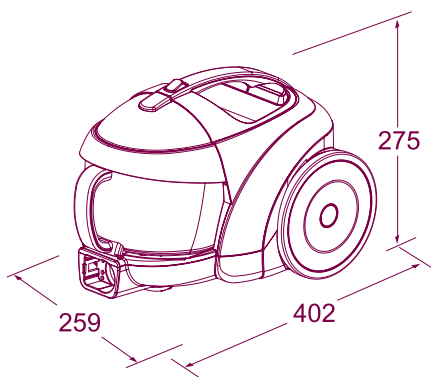

Model: VC3016GHTQY
 220V~ 50Hz
 IEC: 1400W
 MAX: 1600W
 Suction Power: 400W
 Net Weight: 5.0Kg
 Dust Capacity: 1.2L
 Dimension: 402mmx259mmx275mm
 This appliance complies with the following GB Directives:
 GB4706.1-2005
 GB4706.7-2004
 GB17625.1-2003
 GB4343.1-2009

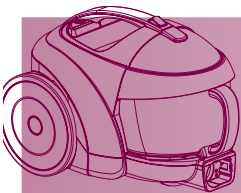

※ You will not be informed otherwise of any changes in appearance and standard deriving for improvement of product quality.



Attention before using the appliance

Attention before using the appliance

Please read all the following information, which contains important instructions for the safety, the use of the appliance.

-  **DANGER** May immediately cause serious injury or death.
-  **WARNING** May possibly cause serious injury or death.
-  **ATTENTION** May possibly cause losses of property or light injury.

DANGER

Do not pick up anything that is burning or smoking, such as cigarettes, matches or hot ashes.

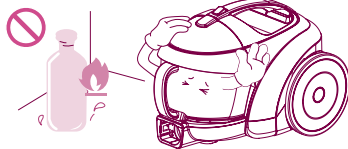

Please turn off the power before pulling out the plug to prevent fire or electric shock. Never handle plug or appliance with wet hands. (Do not use the appliance on the power above 220V.)

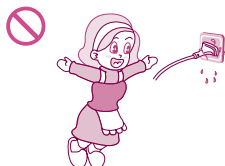

WARNING

Avoid picking up hard, sharp objects with the cleaner. They may damage the cleaner and the tank.

Do not vacuum the objects like hair ball or big paper ball, otherwise the hose is possibly blocked up. Please clear the hose in time when it is blocked.

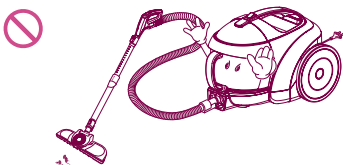

Independently use a socket when the current is $\geq 15A$. It may cause fire when many electric appliances share one socket. In order to avoid the needless danger, you had better not use the prolonged thread of power cord. The current at most 6A is allowed

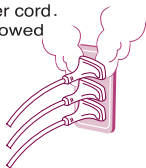

To avoid the danger of fire or electric shock, do not vacuum liquid, blade, flammable substances, or small particles like cement and gesso in cleaning.



Unplug cleaner when not in use. Turn off all controls before unplugging.

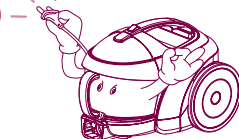

Attention before using the appliance

WARNING

Do not let the power cord near the electric heater or other heat source, lest that the cleaner should be deformed or it should cause fire. Do not use the appliance when the power cord or plug is damaged. The damaged power cord or plug must be replaced in the approved service station.



Close supervision is necessary when any appliance is used by or near children. Do not allow vacuum cleaner to be used as a toy or to run unattended at any time.



Do not operate the appliance for long when the nozzle inlet or nozzle outlet is blocked, which may have it deformed or damaged.

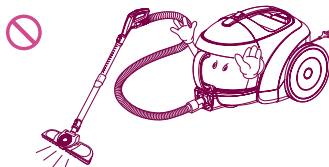

In using the appliance, pay attention to the electrostatic effect generated on the telescopic tube and cleaner body.

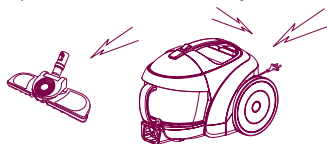

ATTENTION

Do not allow the non-professional maintenance people to repair.

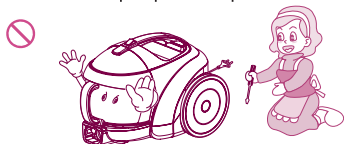

Do not pull or carry by cord, use cord as a handle, close door on cord or pull cord around sharp edges or corners. Do not run appliance over cord. Keep cord away from heated surfaces.

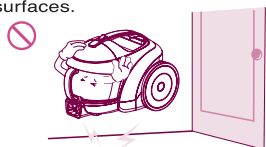

In winding the power cord, hold the plug before pressing the button of the cord reel. Do not pull the power cord beyond the red warning line, other wise the power cord may be damaged or unable to be wound up. Pay attention to the plug in winding the cord to avoid damaging the surrounding objects.



Do not bend, stamp on, or drag the hose. Do not continue to use the hose if it is damaged. Do not use any heavy or sharp object to press the power cord.



Do not use without dust tank or filters in place. Change tank frequently when picking up very fine materials such as powder.

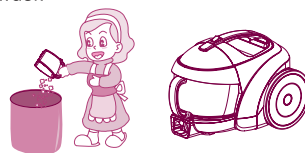

Keep hair, loose clothing, fingers, feet and all parts of body away from the nozzle or movable portion.

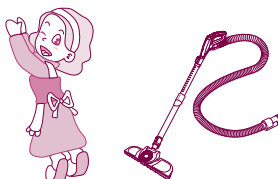

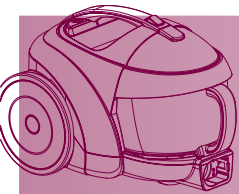

Assembling and adjusting the Cleaner

Parts description and assembly

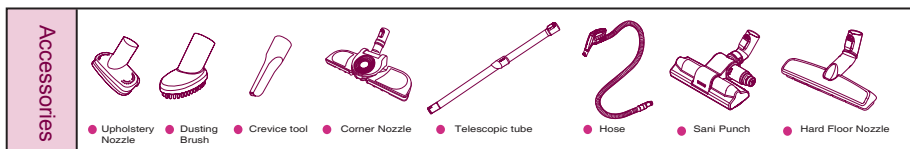
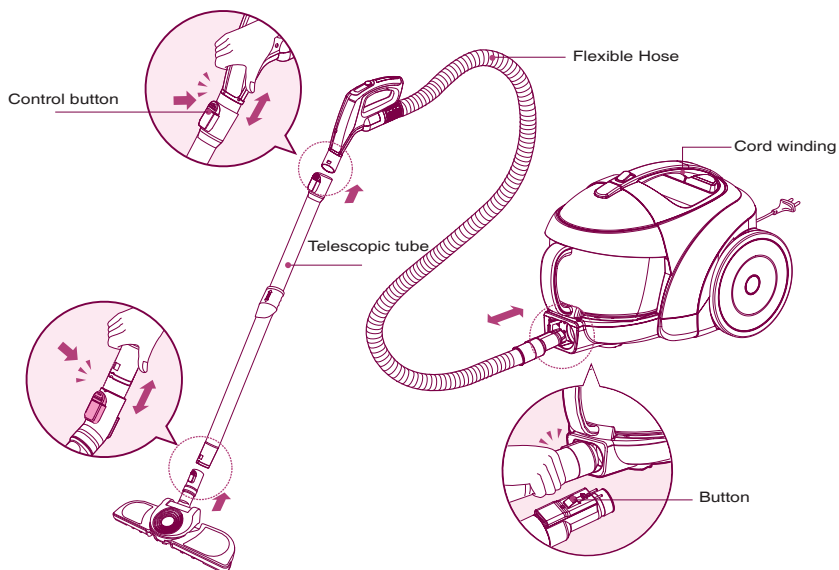

Adjusting the Cleaner

Use it as shown in the diagram

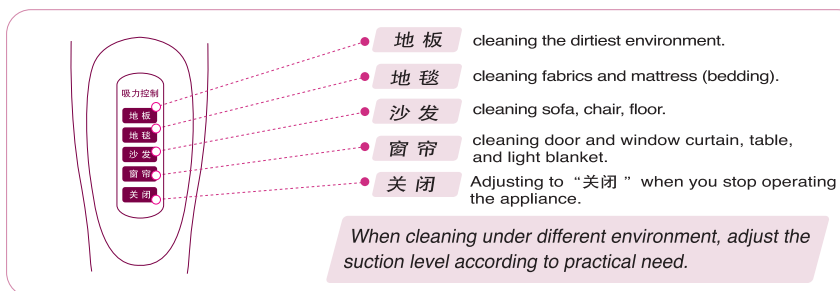

Using crevice tool, upholstery nozzle, dusting brush, corner nozzle and cleaning the corner nozzle

Using crevice tool

Use it as shown in the diagram

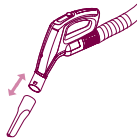

Using method

Nozzle, Crevice can be used for cleaning the place hard to reach.

Using Dust Brush & Upholstery Nozzle

▶ Tear the vinyl bag and pull out accessories.

Use it as shown in the diagram

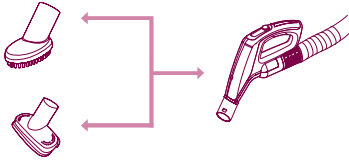

Using method

Nozzle, Crevice can be used for cleaning the place hard to reach.



Using and cleaning the corner nozzle

Assembling

▶ Corner nozzle can be used to clean common floor, also can be used to clean corner when be puckered.

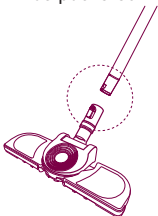

Using

▶ Corner nozzle makes you more convenient to clean corner and small space.

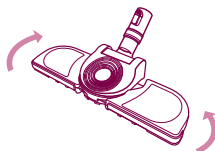

Cleaning

1 Use crevice tool to clean

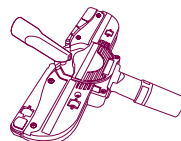

2 Use calico dishcloth to clean

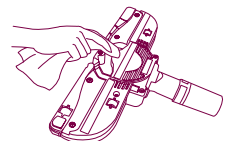

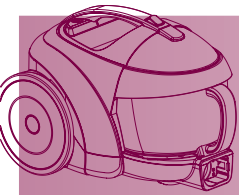

Using and cleaning the Sani Punch

Using the Sani Punch

Use it as shown in the diagram

Assembling



Using



Set the suction power control switch to “地毯” before vacuuming. Depending on the type of bedding, handling may be awkward or it may cause a lot of noise. If this is the case, adjust the suction power control switch to a lower setting.

Effective cleaning

• bed, bedding, heavy blanket

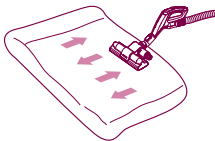

• Light blanket & sheet

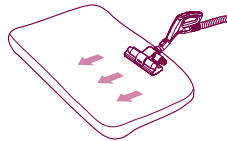

To increase cleaning efficiency for light blankets, lay on top of a bulky blanket and then clean.

- If the punch bar does not move, lift the nozzle slightly off the surface.
- If it does not move, even after doing this, check if the suction power is too low or if the nozzle base is clogged with a foreign object.
- This Sani Punch nozzle is for effective cleaning of beds and blankets to remove mites and dust.

Cleaning the Sani Punch

▶ The vibrator may break down due to the cleansing of the inhaler with water.



1 If the dust settles in the box while cleaning, press the button 2 or 3 times. (It will remove most of the dust.)



2 After the cleaning, if there are lots of dusts in the box, separate the box from the inhaler by turning it anticlockwise.



3 Empty the box.



4 Aim at the Spiral. Fix the box into the inhaler by turning it clockwise.



5 Separate the bottom plate by pressing the buttons in the back.



6 Clean the dirty body of the inhaler carefully with a cloth.



7 Wash the separated bottom plate and dry it in the shade.

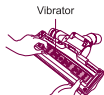

8 Arrange the vibrator in order.



9 Insert the joining spiral into the groove.



10 Attach the bottom plate properly by pressing down.

Using hard floor nozzle

Using hard floor nozzle

Assembling

- ▶ Hard floor nozzle can be used to clean common floor.

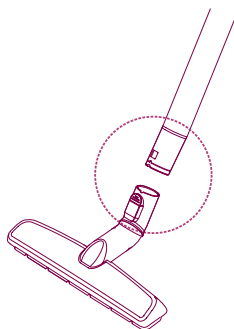

Using

- ▶ Hard floor nozzle makes you more convenient to clean floor.

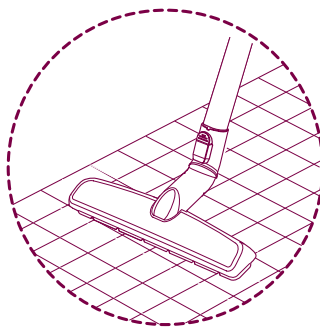

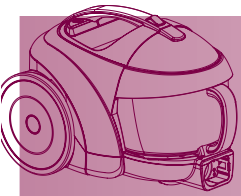

How to separate or empty the dust box

- Warning:**
- Empty the box when the dust settles up to the MAX line.
 - Too much dust beyond this line may reduce the inhaling power.
 - Dust box should be cleaned at least once per 3 months.

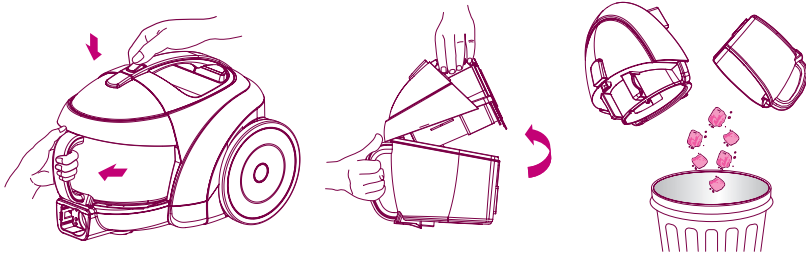

1 Detach the dust tank when press the button.

2 Uncover the dust tank cover by holding its handles.

3 Empty the dust tank.

How to empty the dust separator

- Warning:**
- Check the inside of the dust separator when cleaning the dust box.
 - Clean the inside of the dust separator, because too much foreign substance such as waste paper or plastic in the dust separator may reduce the inhaling power.
 - Dust separator should be cleaned at least once per 3 months.

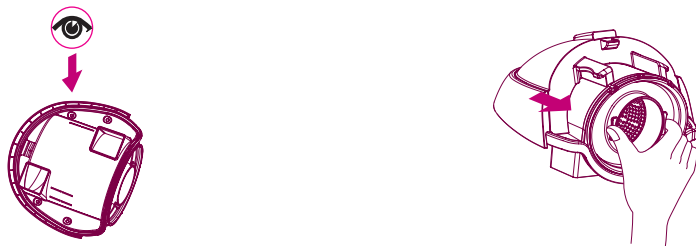

1 Check if the dust has settled in the dust separator.

2 Separate the cover by holding its handle.

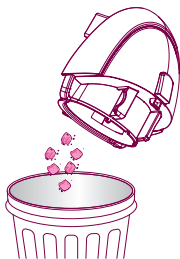

3 Empty the separator.

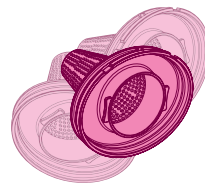

4 Remove the dust from the small holes cover of the separator.

How to clean and assemble the dust box and separator

Cleaning

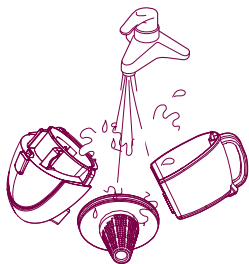

- Cleanse the dust box, separator and its cover with running water.

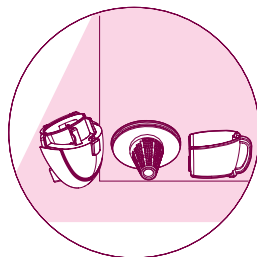

- Dry them in the well-ventilated shade for a day before using.

Assembling

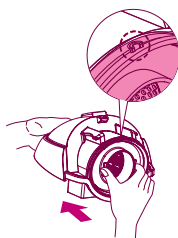

- 1 Attach the cover by inserting the spiral in the cover into the groove.

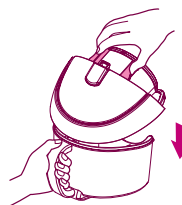

- 2 Assemble the dust separator and box.

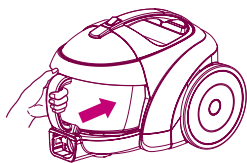

- 3 Attach the assembled dust box to the body of the cleaner.

Warning:

- Do not push the button when you carry the vacuum cleaner. If push the button, it is easy to detach the dust tank from the vacuum cleaner
- If you use the cleaner without assembling the cover of the dust separator, it will increase the noise and reduce the inhaling power when cleaning. So check the assembling once again.

How to separate, clean and assemble the protection filter of the motor

Disassembling

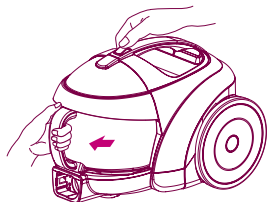

1 Detach the dust tank when press the button.

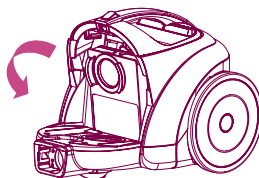

2 Detach the protection filter of the motor from the body after disassembling the dust box.

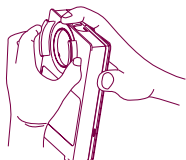

3 Separate it from the filter cover.

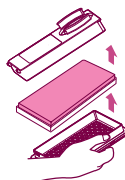

4 Detach the filter.

Cleansing

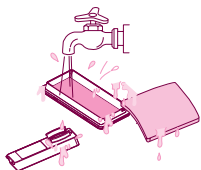

1 Clean with running water.



2 Remove the water completely.

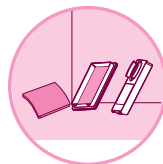

3 Dry in the well-ventilated shade for a day before using.

Warning: • Assembling is done in reverse order of disassembling.

• If you use the cleaner without assembling the protection filter of the motor, noise increases and dust gets into the motor when cleaning, thus leading to the shorter life of the cleaner. So check the assembling once again.

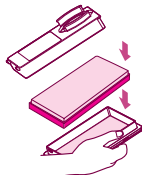

1 Put the filter into the case.



2 Cover the filter.

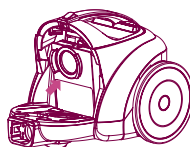

3 Fix the assembled filter.

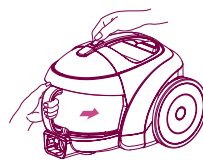

4 Assemble the dust tank.

How to separate, clean and assemble exhaust filter

Disassembling

- ▶ The exhaust filter should be cleaned at least once half a year.
Allow exhaust filter to dry in a shaded location for a dry.

Cover button of the exhaust filter

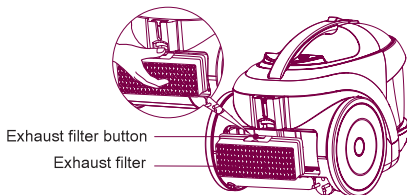
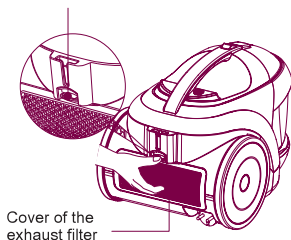

Cleansing



- 1 Shake off the exhaust filter.

Assembling

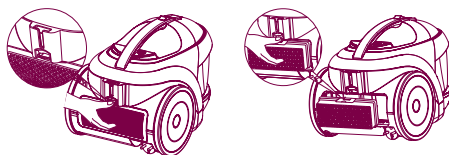

- 2 Insert the exhaust filter and join the cover properly until you hear the click of the button.

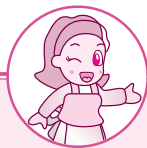

How to keep the cleaner after using

Cord winding button

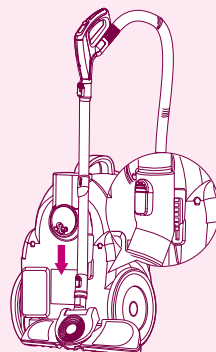
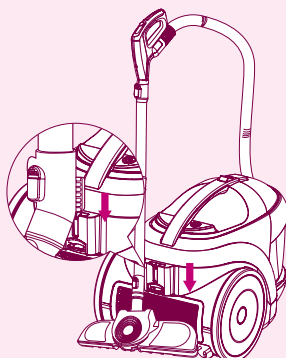
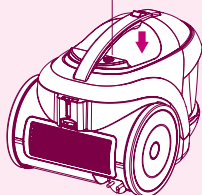

- The cord winds up when you press the button.
- Insert the spiral of the inhaler into the groove in the back or at the bottom of the body

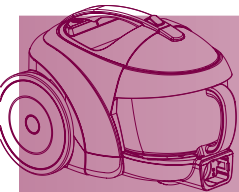

Check before reporting the trouble

- You won't be happy to waste money by calling for service when there is no trouble with the cleaner. Here is good advice to follow for trouble shooting before calling for service. Read the instructions carefully, and you can remove the trouble by yourself.

If inhaling is not well done?

Stage 1 Check if the control button of the inhaling power has been put to "MAX".

Stage 2 Clean the protection filter of the motor.

Disassembling

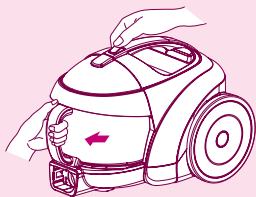

- 1 Uncover the body by pressing the button of the cover.

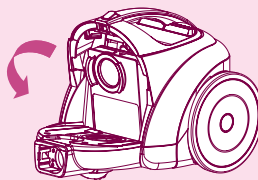

- 2 Detach the protection filter of the motor from the body after disassembling the dust box.

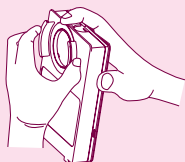

- 3 Separate the filter from the cover by holding the handle of the case.



- 4 Detach the protection filter of the motor.

Cleansing (with cold water)

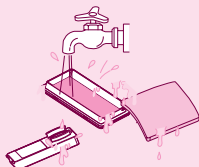

- 1 Cleanse it with running water.



- 2 Remove the water completely.



- 3 Dry it in the well-ventilated shade for a day before using.

If you have a problem

If you have a problem

- ▶ If a minor problem occurs, it usually can be solved quite easily when the cause is found by using the check list below.

Problem:

The noise increases and the hose shrink.



Suction power is abruptly weakened.

Help:

Check the dust tank and suction inlet.



Solution

- 1 Dust tank full. (Arrive at MAX line)
Empty dust tank.



Is it full? Empty the dust tank in time!

- 2 Motor filter dirty.

Clean the motor filter with brush and water, allow to dry and replace in cleaner.



Is the filter OK? Then check the suction inlet.

- 3 When checking the suction inlet, adjust the suction level to the maximum.

First step

Turn cleaner off and disconnect from electrical outlet, then disconnect nozzle from telescopic tube. Check if it is blocked, and remove any blockages.

If there is still a problem, proceed the second step.

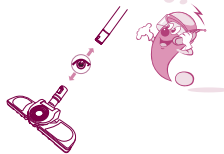

Second step

Disconnect the telescopic tube from hose. Check if it is blocked, and remove any blockages.

If there is still a problem, proceed the third step.



Third step

Plug cleaner in, turn on, and check hose end for suction. Remove any obstructions.

If there is also a problem, clean the filter.



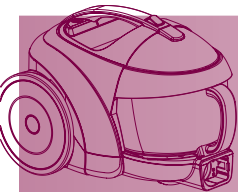

If you have a problem

Please check before notifying malfunction

▶ If you doubt the product meets with malfunction, please check the cause of such malfunction before contacting with the after-sales service center or agent, so as to ensure efficiency of repair.

Malfunction

The vacuum does not work?

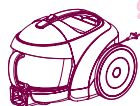

The vacuum does not work?



Peculiar smell exists inside the vacuum cleaner



The power cord can not be scrolled thoroughly into the vacuum cleaner or the power cord can not be fully pulled.



The vacuum cleaner or the discharged air is too heat.



Inner wall of the hose is too dirt.

Check

- Is the plug inserted?
- Is the socket powered on?
- If the hose inserted?
- If the motor heat protection opened?

- When the vacuum cleaner's suction is too large or the motor is under high speed running, they do not belong to the abnormal conditions. So, please use the vacuum cleaner properly.
- If it is the noise rather than the normal motor sound, please phone the repair center.
- The duster collector is filled up.
- The filter is clogged.
- Suction inlet is jammed.
- Drawtube is clogged.
- Hose is clogged.

- When the motor is running, the rubber band used for fixing the motor will produce a little smell due to the heat, but it will not affect the operation or damage the machine.
- When the machine sucks some water accidentally or the dust collector is not cleaned for a long period of time, the peculiar smell will be produced. So, clean up the dust collector timely.

- Pull out part of the power cord and then re-scroll it.
- Please put forth your strength to pull out the power cord, which will not be damaged.
- The power cord entwined inside the machine or it is caused by high temperature in the summer.
- The cord is bended inside the machine or not coiled around the winder. After the winder is started, the normal operation could be realized.

- Is the suction normal?

Troubleshooting

- Insert the plug tight (This product is applicable for 220V)
- Verify the power of socket is on
- Insert the hose tight
- Restart in 2 hours

- Clean out the dust collector.
- Purge the sponge filter with water and air-dry in the shady and cool place for one day.
- Take out the sucked objects before use.
- Take out the objects inside the drawtube before use.
- Take out the objects inside the hose before use.

- The heat air discharged from the machine is arising from the heat produced by motor. So, the temperature is normal, please use the machine continuously.

- Never suck the water because after mixing of the water and dust, the tube wall will be polluted and the motor will be damaged.

Packing List

Packing List

Vacuum Cleaner	1
Owner's Manual	1
Upholstery Nozzle	1
Dust Brush	1
Crevice tool	1
Hose	1
Telescopic tube	1
Corner Nozzle	1
Sani Punch	1
Hard Floor Nozzle	1
Card, Service	1

如有问题

瞬间感动 Moment Of Truth
LG 售后

请打电话



400-819-9999

售后热线

一号通

LG 电子 (天津)电器有限公司

地址: 中国·天津市北辰区津围公路9号

传真: 022-26903476

邮编: 300402

全国技术服务中心服务咨询电话: 400-819-9999



<http://www.lg.com/cn>

P/No.: MFL66099704